



[www.rhopointinstruments.com](http://www.rhopointinstruments.com)



[sales@rhpointinstruments.com](mailto:sales@rhpointinstruments.com)

**RHOPOINT** **iD**  
MEASURE WHAT YOU CAN SEE

### Advanced & Complete Analysis of Transparent Appearance

- Haze measurement correlated with existing standards (ASTM D1003)
- New parameters matched to human perception



# Why measure the appearance quality of transparent materials?

Objects made from transparent materials are common in everyday life, clear plastic is used in packaging film and drinks bottles, windowpanes and windshields are made from glass, mobile phones are protected by a clear protective display.

The function of transparent materials is often to form a barrier which allows a clear view of a protected object or a scene beyond it. Manufactured products however, are rarely perfectly transparent-inhomogenities in base material, surface texture caused during manufacture or scratches and abrasion reduce see-through quality.

As these effects can reduce the perceived quality and functionality it is important that they are accurately quantified. Accurate measurement provides opportunities to optimise materials or processes during manufacture.

Materials with high optical quality have low visual impact on objects viewed through them. The material itself is visually unobtrusive and almost invisible to the observer.

A hazy material causes colour seen through the material to appear washed out or faded. The severity of this loss of contrast is often related to the size of the gap between the object and the material.

A material which blurs the view of objects has low sharpness- this effect can be directional causing a visible pattern to be seen in the material.

Materials with poor optical qualities are visually intrusive and can be described as milky or opalescent. Patterns and texture which may be visible in the material drastically blur viewed objects.

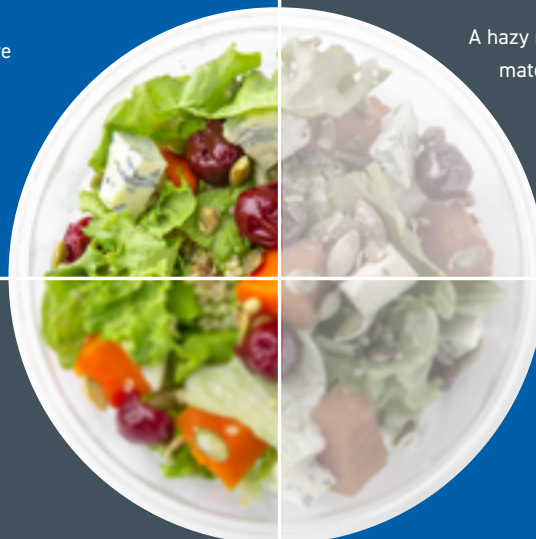

# What is the Rhopoint ID?

The Rhopoint ID is a transmission haze and appearance meter that measures what the eye can see. It quantifies the see-through qualities of materials in a method that can be matched to real world conditions with results highly correlated to customer perception.

The unique Rhopoint ID method fully characterises the transparency of a material in a single measurement.

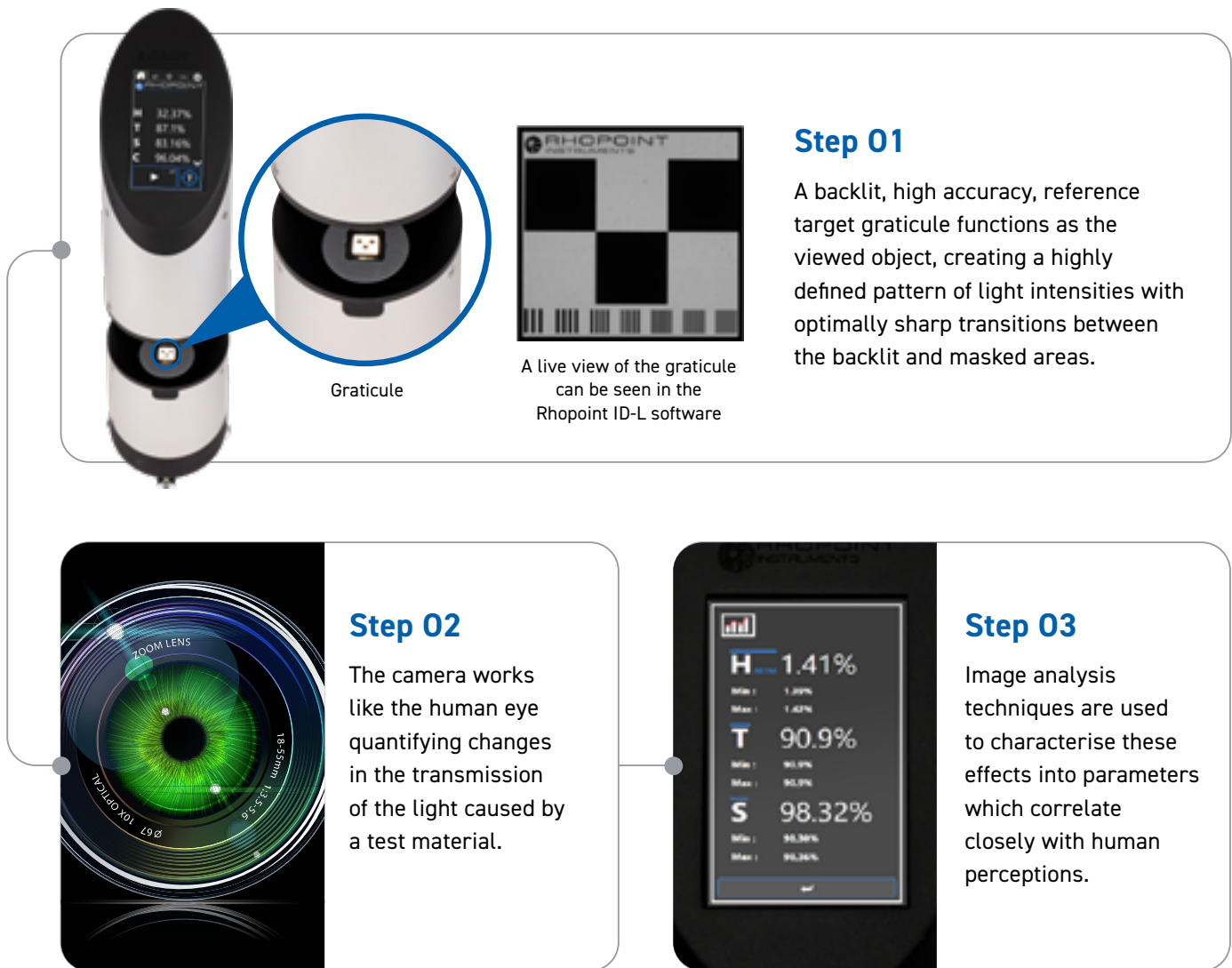

## Applications

ID measurements can be used to quantify the see-through quality of any transparent material: plastic films, plastic sheets, liquids, glass, PET bottles and more...





# Haze

**Haze: quantifies the loss of *contrast* for objects viewed through a material.**



- ✓ Haze is measured directly by evaluating contrast of black and white areas on graticule
- ✓ Measurements made with the Rhopoint ID are fully comparable with those made on an ASTM D1003 hazemeter
- ✓ Automatically operates when ASTM Haze platen (8 mm thickness) is placed in position on instrument between the graticule and a sample
- ✓ Factory calibrated to ASTM standards for a quantitative match

When a material has haze, it changes the appearance of both the material and any objects viewed through it. This can lead to a reduction in perceived quality.

- The product viewed through the material appears lifeless and dull - but details remain sharp.
- The colour of a viewed object appears washed-out and faded.
- The material itself appears cloudy or milky.

## What affects Haze?

Haze can be affected by factors such as the choice of resin, the moulding process and any surface textures. Haze can be caused by:

**Raw material choice:** For example, a plastic with an incorrect melt viscosity for a particular process.

**Process parameters:** Cooling a plastic material too quickly can introduce micro textures onto the surface of the film or structures in the bulk which reduce optical quality.

**Machine wear:** Wear and tear in moulds, chill rollers and slip dies can induce visible surface defects in the material.

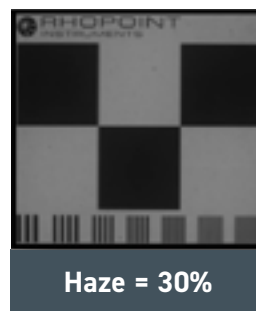

# Sharpness

Sharpness quantifies the loss of perceived detail for objects viewed through a material.

## What are the effects of reduced Sharpness?

When viewed through a material with high sharpness, an object appears sharp and distinct. As material sharpness decreases, the object appears blurry and obscured.



## Anisotropic Sharpness. Only available with Rhopoint ID-L version.

A material can often exhibit optical effects which are *directional*. These phenomena are often induced in plastic parts by specific processing faults.

Visible texture is a common feature of plastic films and causes a significant reduction in their see-through quality.

## Directional Effects

The Rhopoint ID is the only instrument that can measure directional effects in materials using the ID laboratory analysis software.

The images to the right show the visual impact of different ID Sharpness (S) values in vertical and horizontal directions.

Measuring directional effects can be used in advanced optical quality control and for adjusting processing parameters to obtain optimal transparency.

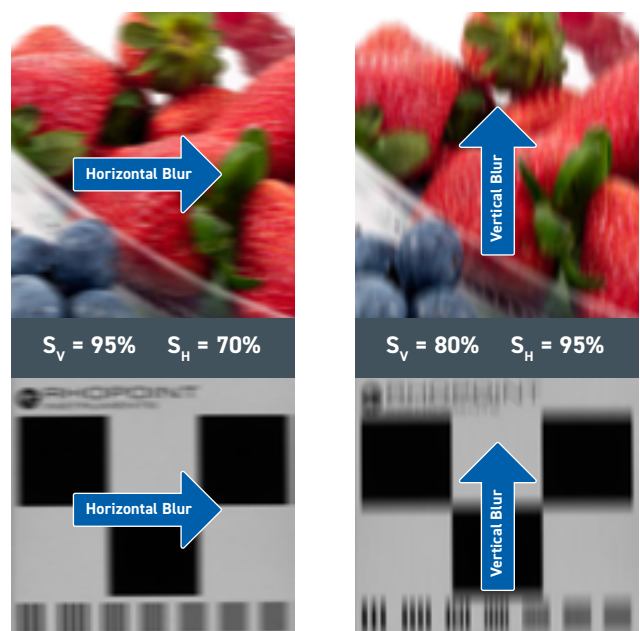

# Clarity

## What is Clarity?

Quantifies the blurriness of an object when viewed through a material, results are proportionate with Sharpness, but the measurement scale is compressed and the measurement resolution is reduced.

Clarity is a scale used by traditional haze and clarity meters. When measured using the 8mm adaptor plate, Rhopoint ID Clarity data conforms to specifications written for these meters.

Inter-instrument Clarity agreement between Rhopoint ID and traditional sphere instruments for commercial plastic films (<1000µm) is typically <0.4% C (SD).

Inter-instrument Clarity agreement between traditional sphere instruments and Rhopoint ID for thick transparent plastic materials (<6mm) is typically <0.5% C (SD).



High clarity



Medium clarity



Low clarity

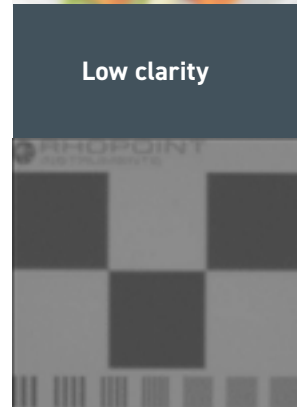
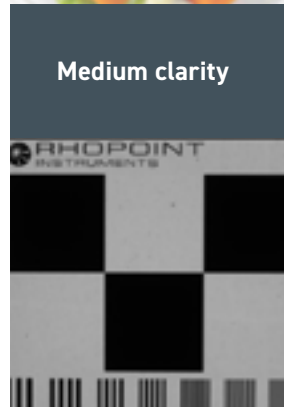
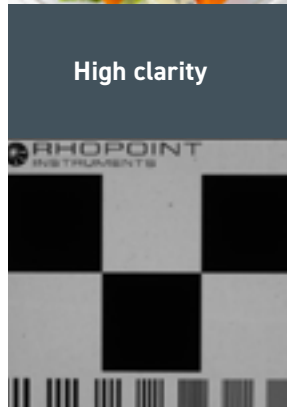

- ✓ ID sharpness gives improved measurement resolution compared with clarity
- ✓ ID Clarity is fully compatible with existing instruments

Note: Clarity and Sharpness do NOT capture poor optical characteristics associated with wavy/orange peel surfaces

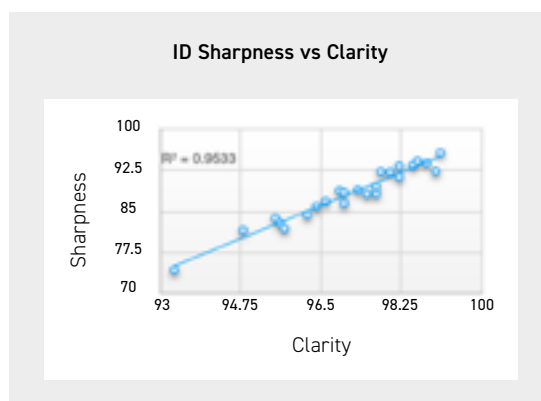

**ID Sharpness measurement**  
Better measurement resolution than clarity.

**ID Clarity**  
Compatible measurement with existing measurements.

# Waviness

## What is Waviness?

Waviness is an optical effect caused by large structures (0.1-2mm) on the surface of the material. If the structure is homogeneous it is often described as orange peel - the surface resembles the peel of an orange.

If the effect is anisotropic, visible lines can often be seen when looking through the material.

Unlike sharpness, these larger structures can cause dynamic distortion when the film is moved over a target image/object which has straight edges - the edges appear to distort and wave as the material is moved.

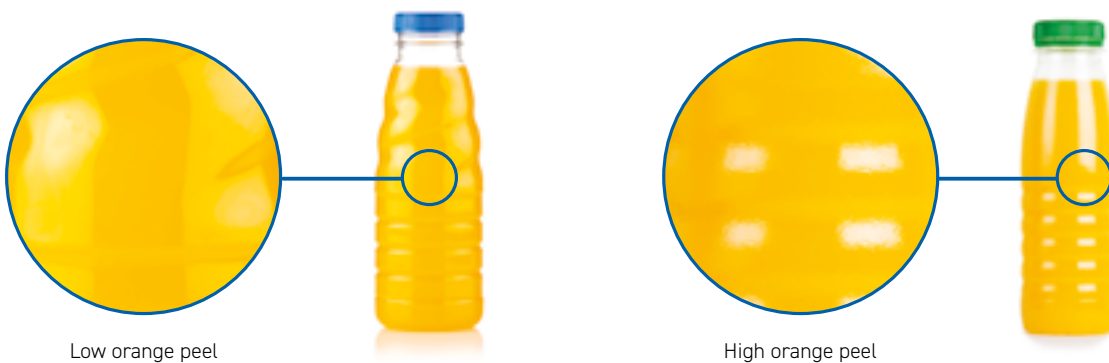

## How is Waviness measured?

Waviness measures the visible distortion of the ID graticule edges through the material.  $W$  is the standard deviation of the edge deformation in  $\mu\text{m}$ .

Waviness homogeneity is assessed by comparing  $W$  (average waviness) with  $W_h$  (horizontal waviness) and  $W_v$  (vertical waviness) using Rhopoint ID software.

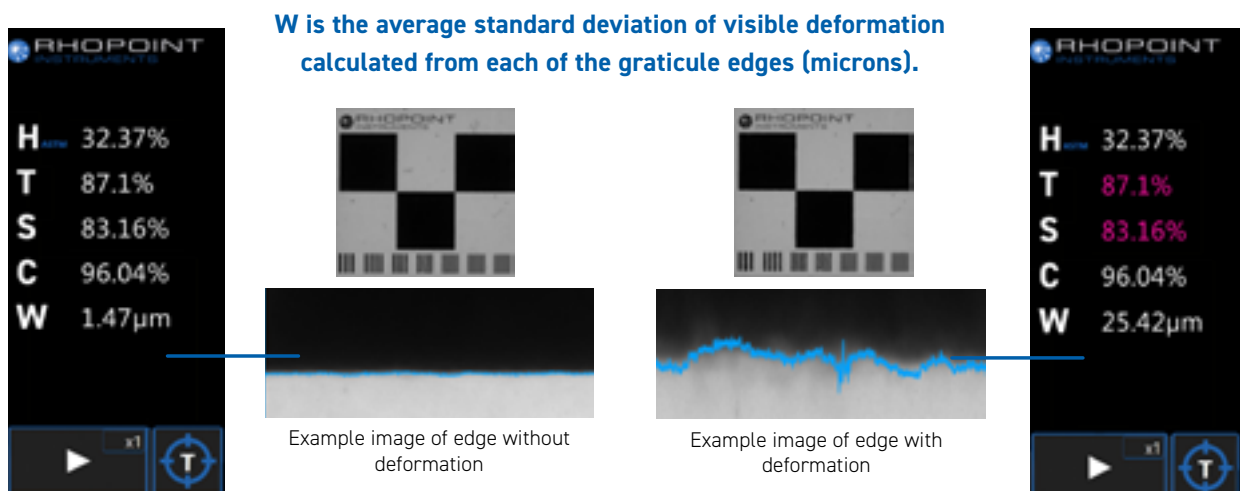

**$W(h)$  and  $W(v)$  in the ID software can be used to quantify anisotropy**

# Distance Dependent Haze

Many materials exhibit a variation of transparency depending on whether the material is in contact with a viewed object, or separated by an 'air gap' distance between them.

## Why is Distance Dependence important?

Matching the material exactly to the application allows quality improvements and production cost savings.

To match a specific material application the Rhopoint ID can measure ID Haze at any distance within 0–40 mm. Using the ID it is possible to identify the air gap distance at which maximum Haze is obtained (typically <25 mm).

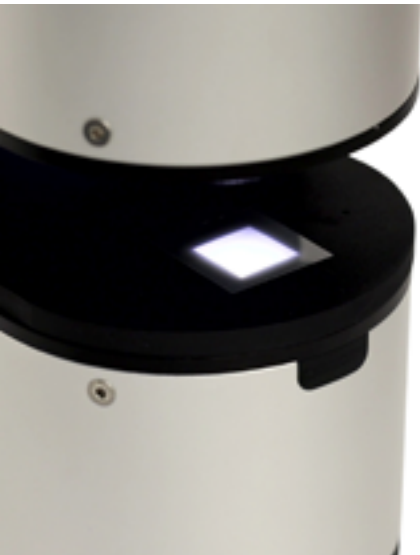

## Haze and Distance

The images below show the effect of air gap distance for a hazy plastic film held in front of an image.



Contact  
H = 9.99



Haze to ASTM  
D1003 (8mm)  
 $H_{ASTM} = 30.98$



30mm Distance  
H = 76.74

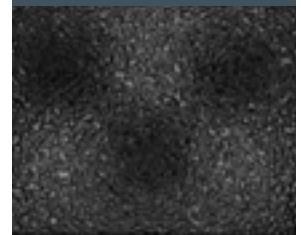
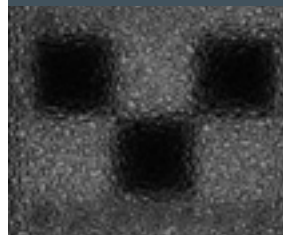
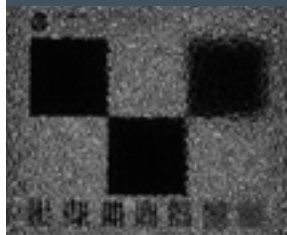

- ✓ Direct measurement of haze from transmission image contrast
- ✓ Measured in contact or at user-defined distance between material and object (0–40 mm)
- ✓ Measures distance dependence on the same scale as ASTM Haze
- ✓ Direct measurement of transparency via contrast of black and white areas on target graticule
- ✓ Measure and understand distance dependent haze

**High distance dependence of haze** is desirable for privacy/security glass and films which are designed to obscure a view without blocking light.



# Visible Transmittance

When considering how material is perceived by a consumer it is important to consider how bright an object viewed through it will appear.\*

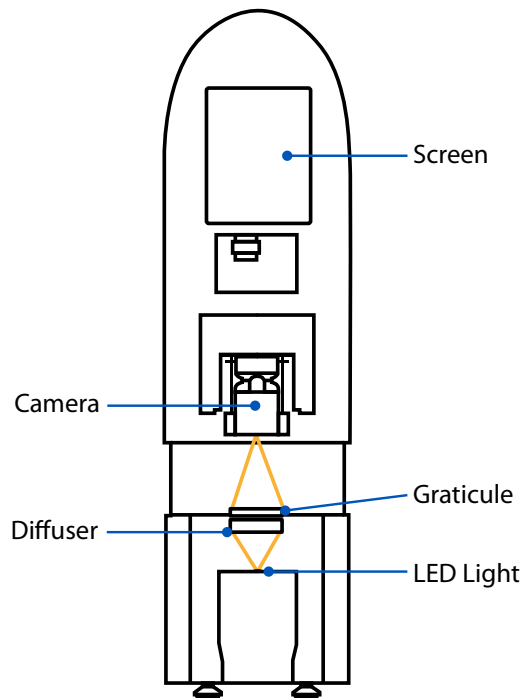

## Visible Transmission to human observer

- Rhopoint Transmittance (TID) quantifies the amount of light passing through the material and reaching the camera/eye of the observer.
- This measurement describes the brightness/ luminosity of the viewed object and is correlated to how one perceives the quality of the material.

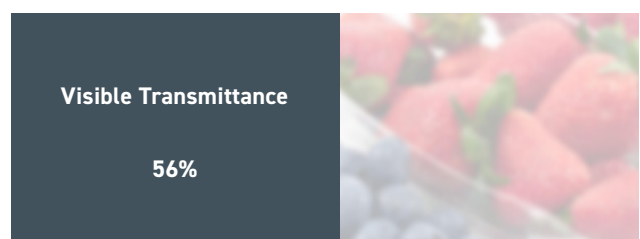
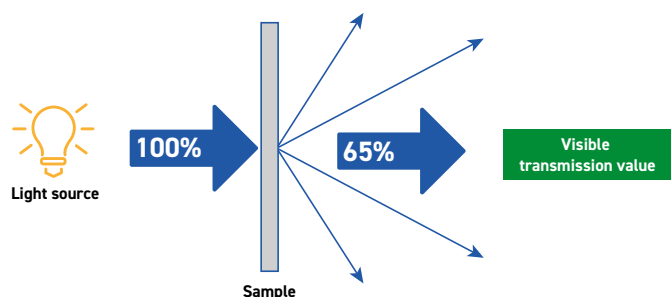

\*Traditional hazemeters measure total transmission which is related to light absorption not visual perception

# Applications

The Rhopoint ID is designed to measure transparent materials including the following applications



## Films

Analyse surface roughness and bulk irregularities of packaging films. Optimise distance related see-through quality.



## PET bottles

Evaluate orange peel and texturing on external wall surfaces, Mould lines / marks or contamination in PET blow moulding processes.



## Windscreens

Analyse wiper wear resistance (wiper resistance test - ISO 12-103-1 A4) on automotive windscreen glass.



## Mobile phones

Measure the optical quality of display films and glass.



## Display films

Quantify the transparency of display films. Detect local defects.



## Liquids, gels and pastes

Safely quantify the transparency of liquid and semi-liquid materials.



## Recycled materials

Ensure the quality of recycled materials in new products meets accepted standards for transparency.



## Rigid plastics

Evaluate and optimise the use of clarifying additives in polypropylene packaging and containers.



## Tubes and Pipes

Glass, plastic or silicone pipes and tubing with a diameter >6mm



# Instrument features

The Rhopoint ID has been designed to measure samples for haze, transmittance and sharpness quickly and safely.



**No moving parts**

Eliminates risk of mechanical failure



**Stand-alone instrument**

Small footprint reduces space required in laboratory



**Lightweight**

Easy to move in the laboratory or production line



**Resistant and durable**

Made from durable, recyclable materials



**Touch screen**

Single measurement time of 2 seconds to measure ALL parameters (up to 15 seconds on a comparable sphere instrument)

**Large mounting area**

Minimal sample preparation required possible to measure non flat samples without bending or deforming.

**Fully sealed optics**

Ideal for measuring liquid samples and solid materials impervious to damage through accidental spillage



Production



Laboratory



Research

# Analysis Software

Rhpoint ID-L software offers detailed visual analysis of samples using LIVE VIEW. Statistical analysis of multiple test results is shown for each measured parameter.



- Saves all the results as a CSV file
- Imports previous CSV results
- Saves CSV results and all images as tiff
- Imports CSV results and image tiff files

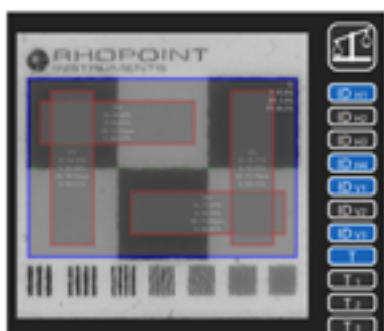
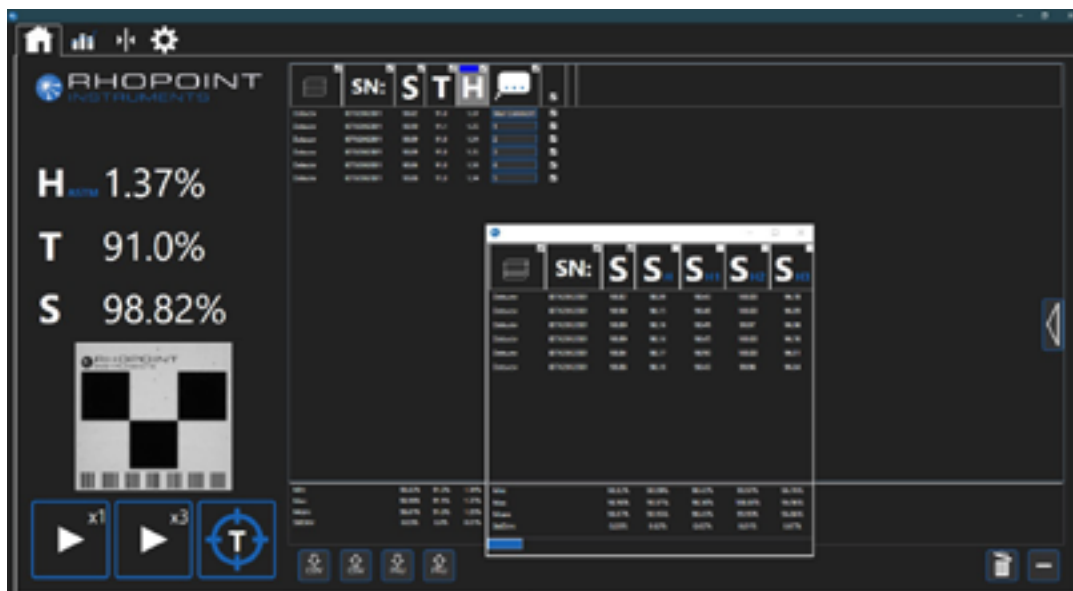

**Caption title**

Text tbc

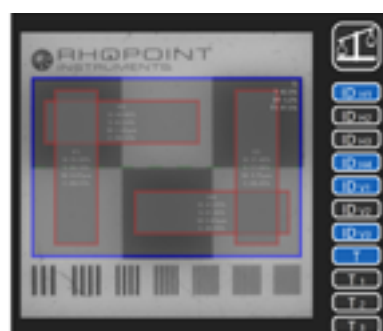

**Caption title**

Text tbc

# Rhpoint ID-L Optional Accessories



## Surface Roughness Adaptor

The Surface Roughness Adaptor allows the roughness of the film on each side to be isolated and measured without submersing the material in oil.



## Abrasion Adaptor

Allows Taber abraded samples to be mounted on the Rhpoint ID. Results are highly correlated to ASTM D1044.



## 20mm Distance Haze Pack

Spacers for distance dependency haze measurement.

- 2 x 5mm spacers.
- 5 x 2mm spacers.
- 2 packs of spacers can be combined for a 40mm distance.
- Custom spacers are available.

# Specifications

	Sharpness	Haze		Waviness	Clarity	Transmission
Range	0-100%	0-10%	10-100%	0-500µm	0-100%	0-100%
Resolution	0.01 [%]	0.01 [%]	0.01 [%]	0.01 [%]	0.01 [%]	0.01 [%] (Reported 0.1 [%])
Repeatability SD	0.1	0.05	0.05	0.4	0.03	0.05
Reproducibility SD	1	0.2	0.5	0.8	0.3	0.1

ID-L	
Measurement Mode	Contact and Non Contact
Non Contact Distance	Up to 40mm
Material Thickness	<30mm
Software	Rhpoint ID-Analysis
Connection	Ethernet LAN
Spatial Resolution	12µm
Imaged Area	20mm x 20mm
Minimum measurement area (Haze, Sharpness)	6x2mm
Minimum measurement area (Transmittance)	2x2mm
Image Format	16 Bit Tiff
Image Sensor Size	1280x1024
Operating Temperature	10-40°C
Dimensions h x Ø	470 x 125 mm
Weight	3.95 Kg
Packed Weight	6.7 Kg
Power	110/230V

Product	Included accessories	Order code
Rhpoint ID-L	1 x USB drive (contains software / manual ) · 1 x checking standard · 1 x calibration certificate 1 x 8mm spacer (ASTM) · 1 x 5mm spacer · 1x LAN cable and 1x USB2 to LAN adaptor	A3100-001

Optional accessories for ID-L	Order code
Abrasion adaptor	B3100-002
Surface roughness adaptor	B3100-003
20mm distance haze pack	B3100-001
Rhpoint transmission check standard - 25%	B3100-012
Rhpoint transmission check standard - 50%	B3100-011
Rhpoint transmission check standard - 70%	B3100-008

**Free extended 2 year warranty:** Requires registration at [www.rhpointinstruments.com](http://www.rhpointinstruments.com) within 28 days of purchase. Without registration, 1 year standard warranty applies.

# ID measurement - inline

The Rhopoint ID-Inline is a camera-based system which fully quantifies product transparency with parameters that are highly correlated to human perception.

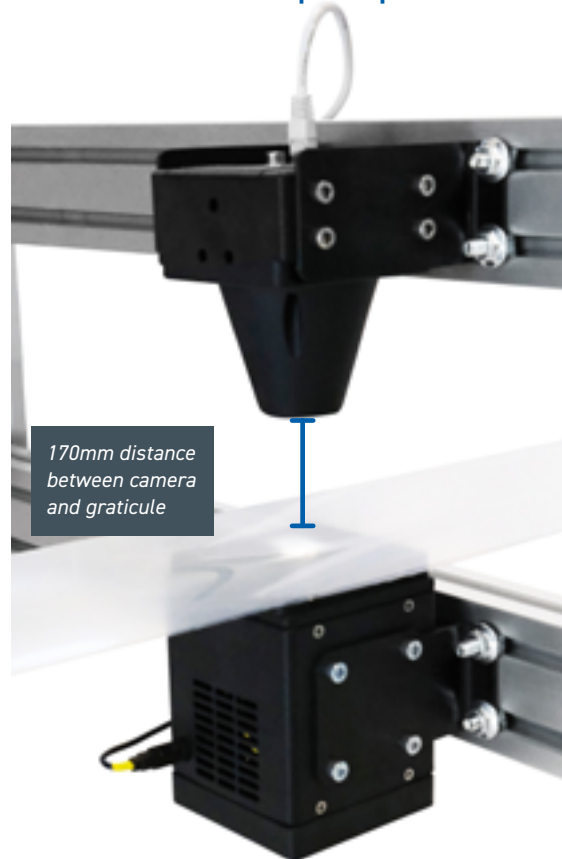
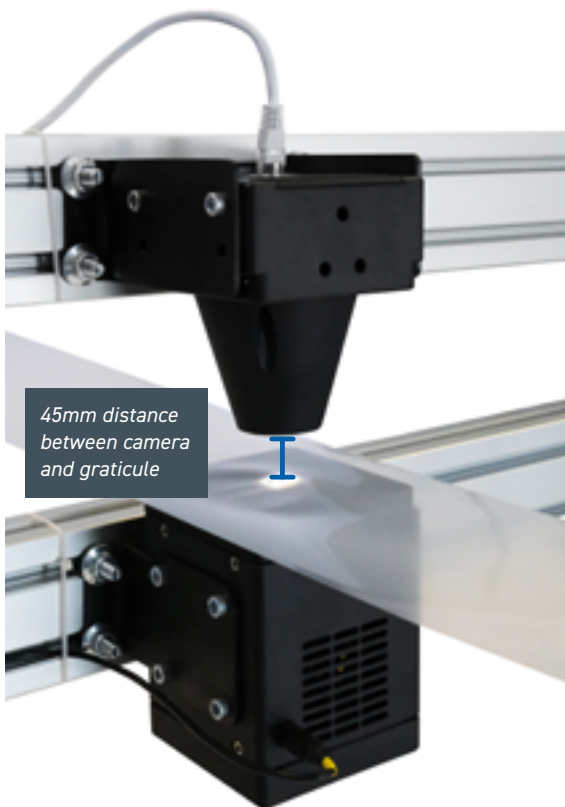

## Short focal distance

The Rhopoint ID-Inline can be used for non-contact measurement of any sheeted or planar material - including plastic films, or glass. The Rhopoint ID-Inline can also be used for non-contact inline measurement of glass or plastic tubes.

## Long focal distance

This version is most suitable for production processes where the large focal distance is more suited to the customer production line.



## Measurement Station

Either version can be incorporated into an inspection station for 3D parts or large sheets of plastic or glass.

Standard or extended clearance models are available to encompass a wide variety of parts and installation configurations.

[View product online](#)



**TRY BEFORE YOU BUY**

## We offer two options for you to try out the Rhopoint ID before buying.

- 1 Online demonstration:** Online presentation of the Rhopoint ID with your samples measured LIVE on Zoom, TEAMS or Skype. Includes a consultation with an application specialist.
- 2 Factory sample testing:** Send in samples of your material for testing and receive a comprehensive test report.

[Arrange a demo](#)

Ready to receive a quote?

[Click here](#)

Rhopoint Instruments Ltd  
Rhopoint House, Enviro 21 Park,  
Queensway Avenue South,  
St Leonards on Sea, TN38 9AG, UK  
T: +44 (0)1424 739 622  
E: [sales@rhopointinstruments.com](mailto:sales@rhopointinstruments.com)  
[www.rhopointinstruments.com](http://www.rhopointinstruments.com)

Rhopoint Americas Inc.  
1000 John R Road,  
Suite 209, Troy,  
MI 48083, USA  
T: 1.248.850.7171  
E: [sales@rhopointamericas.com](mailto:sales@rhopointamericas.com)  
[www.rhopointamericas.com](http://www.rhopointamericas.com)

Rhopoint Instruments GmbH  
Seebauer Office Center,  
Am Weigfeld 24,  
83629 Weyarn, Deutschland  
T: +49 8020 9214-988  
E: [info@rhopointinstruments.de](mailto:info@rhopointinstruments.de)  
[www.rhopointinstruments.de](http://www.rhopointinstruments.de)



All images are for illustrative purposes only  
E&OE ©Rhopoint Instruments Ltd. July 2023